

RIELLO 40 F SERIES

The Riello 40 F series of one stage light oil burners, is a complete range of products developed to respond to any request for light industrial applications.

The Riello 40 F series is available in three different models, with an output ranging from 30 to 202 kW, divided in three different structures.

All the models use the same components designed by Riello for the Riello 40 F series.

The high quality level guarantees safe working. In developing these burners, special attention was paid to reducing noise, to the ease of installation and adjustment, to obtaining the smallest size possible to fit into any sort of boiler available on the market.

All the models are approved by the EN 267 European Standard and conform to European Directives for EMC, Low Voltage, Machinery and Boiler Efficiency.

All the Riello 40 F burners are fired before leaving the factory.



F5	30 ÷ 60 kW
F10	54 ÷ 107 kW
F20	95 ÷ 202 kW

Guidelines for installation of burners in conformity to EU Regulation:

A RIELLO burner (Heat Generator), where it is matched with a water-based boiler (Heater Housing) with a nominal output ≤ 400 kW, providing heat for heating purposes and heat to deliver sanitary hot water, can be installed:

- With boilers (heater housings) already in service in the field, for replacement of identical products, in conformity to Article 1, paragraph 2, point (G) of the EU Regulation No. 813/2013;
- With boilers (heater housings) on a new installation, if they have emissions complying with the requirement of Annex II, paragraph 4 of the EU regulation No. 813/2013.

FIRING RATES

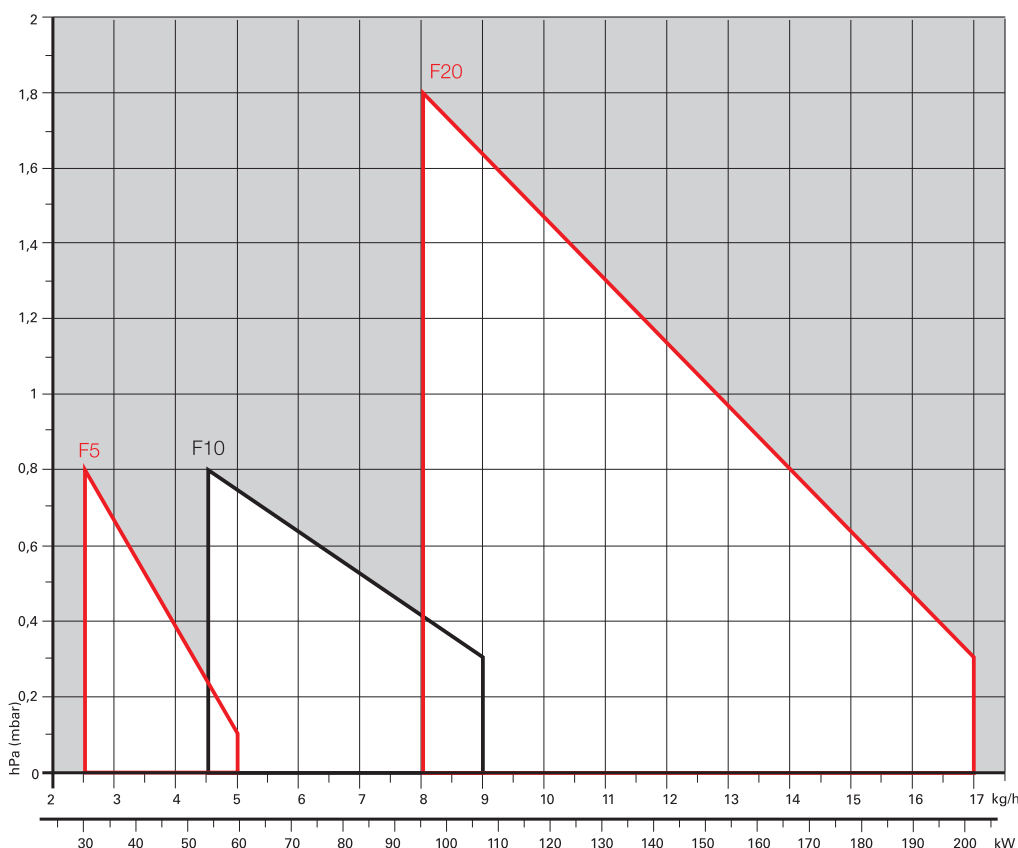

Useful working field for choosing the burner

Test conditions conforming to EN267
 Temperature: 20°C
 Pressure: 1013,5 mbar
 Altitude: 0 m a.s.l.

Light Oil Oven Burners

RIELLO 40 F SERIES

Overall dimensions (mm)

BURNER

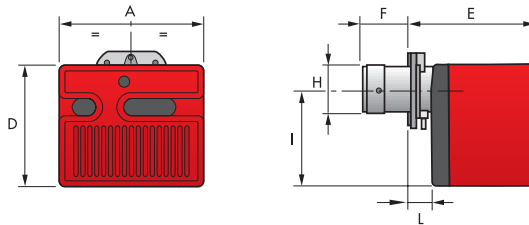

MODEL	A	D	E	F	H	I	L
► F5	272	233	240	72	89	180	41
► F10	305	262	265	104	105	204	44
► F20	350	298	299	118	125	230	45

BURNER - BOILER MOUNTING FLANGE

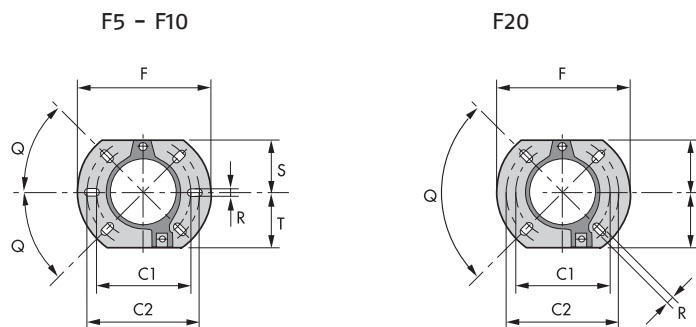

MODEL	C1	C2	F	Q	R	S	T
► F5	130	150	180	45°	11	72	75
► F10	140	170	189	45°	11	83	83
► F20	160	190	213	90°	11	99	99

PACKAGING

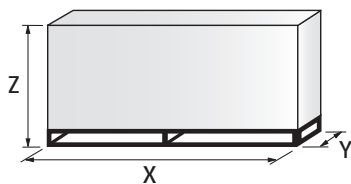

MODEL	X	Y	Z	kg
► F5	383	315	325	12
► F10	423	348	340	13
► F20	483	393	377	16

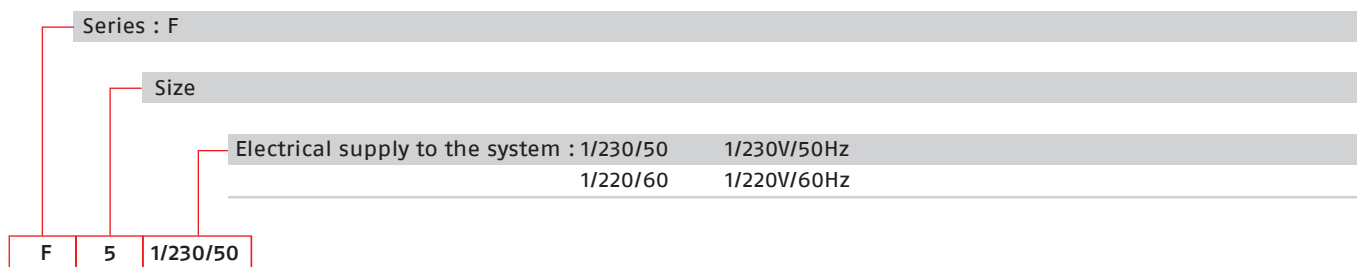
RIELLO 40 F SERIES**Specification****DESIGNATION OF SERIES****STATE OF SUPPLY**

Completely automatic monobloc light oil burners, one stage operation, made up of:

- Fan with forward curve blades
- Metallic cover
- Fixed air damper with adjustment
- Single phase electric motor 230 V, 50 Hz
- Combustion head fitted with:
 - stainless steel head cone, resistant to high temperatures
 - ignition electrodes
 - flame stability disk
- Geared pump for fuel supply, fitted with:
 - filter
 - pressure regulator
 - attachments for fitting a pressure gauge and vacuum meter
 - internal by-pass for preparing for single-pipe installations
- Fuel feed solenoid valve incorporated in the pump
- Photocell for flame detection
- Electronic flame control equipment
- Light oil nozzle
- IP X0D (IP 40) protection level.

Standard equipment:

- Two flexible pipes for connection to the light oil supply line
- Two nipples for connection to the pump
- Flange, screws and nuts for fixing
- Thermal screen
- Instruction handbook for installation, use and maintenance
- Spare parts catalogue.

Available models

CODE	MODEL	HEAT OUTPUT		TOTAL ELECTRICAL POWER (kW)	NOTE
		(kW)	(kg/h)		
3451083	F5	1/230/50	30 - 60	2,5 - 5	0,130
3746159	F5	1/220/60	30 - 60	2,5 - 5	0,180
3452083	F10	1/230/50	54 - 107	4,5 - 9	0,170
3746260	F10	1/220/60	54 - 107	4,5 - 9	0,200
3452783	F20	1/230/50	95 - 202	8 - 17	0,320
3747260	F20	1/220/60	95 - 213	8 - 18	0,400

Net calorific value: 11,8 kWh/kg - 10200 kcal/kg - Viscosity at 20°C: 4÷6 mm²/s (cSt)
The burners of F series are in according to EN 267.

Burner accessories

Remote control release kit for 530 SE control box

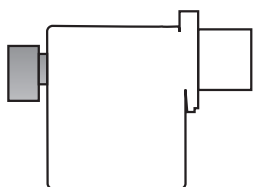

The 530 SE control box can be remotely released using an electric command kit. This kit must be installed in conformity with current regulations in force.

BURNER	KIT CODE
► F5 - F10 - F20	3001030

Extended head kit

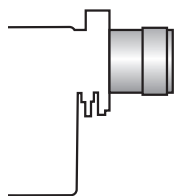

Kits of extended heads are available.

BURNER	STANDARD HEAD LENGTH (mm)	EXTENDED HEAD LENGTH (mm)	KIT CODE
► F5	72	107	3000638
► F10	104	168	3000643
► F10	104	250	3000770
► F20	118	178	3000644
► F20	118	260	3000771

Burner accessories

Spacer kit

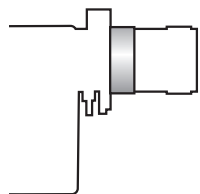

Using the special accessories, the burner can be pulled back to reduce head penetration into the combustion chamber.

BURNER	SPACER THICKNESS S (mm)	KIT CODE
► F5	25	3000642
► F10	25	3000672
► F20	15	20103452

Inlet air aspiration kit

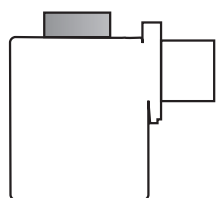

This kit allows to channel the external air directly into the burner and is available as accessory for models:

BURNER	KIT CODE
► F5	20027574
► F10	20027577
► F20	20027580

Light oil filter



For cleaning light oil from dirty particles and impurities filters with the following features are available:

BURNER	FILTERING DEGREE (µm)	KIT CODE
► All models	60	3006561

Filter made up of aluminium body and stainless steel filtering cartridge; available singularly.

BURNER	FILTERING DEGREE (µm)	KIT CODE
► All models	60	3075011

Filter made up of aluminium cover, plastic tank and nylon filtering cartridge; available in packaging of 50 pieces.

Light oil filter/degassing unit



To solve problems of air or water in the oil circuit a special filter/degassing unit is available, made up of aluminium cover, plastic tank, stainless steel filtering cartridge, air release cap and water purge valve. It is available singularly.

BURNER	FILTERING DEGREE (µm)	KIT CODE
► All models	100	3000926

7-pin plug kit

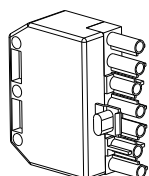

If necessary a 7-pin plug kit is available (in packaging of n. 5 pieces).

BURNER	KIT CODE
► All models	3000945

Light Oil Oven Burners

RIELLO 40 F SERIES

Burner accessories

Hour counter kit for 530 SE and 531 SE control boxes



To measure the burner working time a hour counter kit is available.

BURNER	KIT CODE
► All models	3000904

7-pole socket kit for 530 SE and 531 SE control boxes

For burner without pre installed socket a 7-pole socket kit with cable is available.

BURNER	KIT CODE
► All models	3001065